

# Private transport modelled in SATIMGE and the socio-economic impacts of electric vehicles in South Africa

Bruno Merven, Faaqqa Hartley, Jules Schers and  
Fadiel Ahjum

SA-TIED Working Paper #121 | June 2020



## About the project

### Southern Africa –Towards Inclusive Economic Development (SA-TIED)

SA-TIED is a unique collaboration between local and international research institutes and the government of South Africa. Its primary goal is to improve the interface between research and policy by producing cutting-edge research for inclusive growth and economic transformation in the southern African region. It is hoped that the SA-TIED programme will lead to greater institutional and individual capacities, improve database management and data analysis, and provide research outputs that assist in the formulation of evidence-based economic policy.

The collaboration is between the United Nations University World Institute for Development Economics Research (UNU-WIDER), the National Treasury of South Africa, the International Food Policy Research Institute (IFPRI), the Department of Monitoring, Planning, and Evaluation, the Department of Trade and Industry, South African Revenue Services, Trade and Industrial Policy Strategies, and other universities and institutes. It is funded by the National Treasury of South Africa, the Department of Trade and Industry of South Africa, the Delegation of the European Union to South Africa, IFPRI, and UNU-WIDER through the Institute's contributions from Finland, Sweden, and the United Kingdom to its research programme.

Copyright © Authors 2020

The views expressed in this paper are those of the author(s), and do not necessarily reflect the views of the of the SA-TIED programme partners or its donors.



## Private transport modelled in SATIMGE and the socio-economic impacts of electric vehicles in South Africa

---

Bruno Merven, Faaïqa Hartley, Jules Schers and Fadiel Ahjum

### ABSTRACT

This paper presents an alternative methodology to modelling private transport in the hard-linked energy-economic model, SATIMGE. The methodology considers a shift from total fuel consumption in the economic model to end-use energy consumption for the private transport sector. The results show an improved synergy between the energy and economic models in the hard-linked model. The paper uses the new model to assess the energy, emissions and economic impacts of electric vehicle adoption in South Africa. The results show that shifting from traditional fossil fuel technologies to cleaner alternatives are beneficial for emissions reductions without being harmful to economic growth over the long term. The impact is, however, dependent on the rebound effect of behavioural changes to fuel economy improvements.

## 1 INTRODUCTION

The transport sector accounts for 14% of total energy-related CO<sub>2</sub> emissions in South Africa. As such it is the second-largest emitting sector, just after power generation and on a par with industry. The sector is directly linked to emissions produced within the industrial sector, specifically liquid fuels, with nearly all vehicles that use internal combustion engine technologies requiring petrol or diesel as an energy input. Nearly 100% of petrol and 76% of diesel consumed in South Africa is accounted for by the transport sector. Residential transport, which includes public and private passenger transport, accounts for roughly half of total transport energy consumption and 6% of total energy-related emissions. Mitigation policies to reduce South Africa's emissions will therefore need to include measures to reduce emissions in the transport sector, including in private transport.

Advances in clean energy technologies over the past ten years have provided alternatives for mobility which enable a reduction in emissions within the transport sector without negatively affecting emissions in other sectors. Ahjum et al. (2019), for example, show that increasing electric vehicle (EV) use in private and freight transport from practically nothing in recent years to 80% of the total vehicle parc in 2045 could reduce transport emissions by 45% and total emissions by 12%, as the shift would lead to a decline in demand for petrol and diesel. Global shifts to EVs are already underway, with growth in electric car deployment increasing over the past ten years. In 2018 the global stock of electric passenger cars exceeded five million. Under announced policy ambitions, the International Energy Agency (IEA) (2019) estimates that global EV sales will reach 23 million by 2030. This would cut demand for oil products by 127 million tonnes of oil equivalent (Mtoe) or 2.5 million barrels per day and reduce well-to-wheel GHG emissions by nearly 50% relative to emissions that would have resulted from a fleet of internal combustion engine (ICE) vehicles of equivalent size.

In developing countries, the commitment to reduce emissions must be balanced with the economic development impacts of doing so. The need for the requisite analysis has resulted in the development of assessment tools that include energy detailed economic models, macroeconomic module-linked energy models, or combined models to provide a consistent framework for analysis. A criticism of these tools is the different approaches it takes to estimating household energy demand. Energy models generally estimate household energy demand based on end-use demand and technologies available to meet this demand, whereas the end-use demand is estimated based on changes in household income.<sup>1</sup> Economic models use generalized behavioural functional forms, such as the Linear Expenditure System or Cobb Douglas functional forms, to determine expenditures on goods and services classified according to the standard Classification of Individual Consumption According to Purpose (COICOP). In the case of energy, they therefore do not generally distinguish between energy end-uses.

The SATIMGE model, a hard-linked full sector energy TIMES model (SATIM) and Computable General Equilibrium (CGE) economy-wide model for South Africa (eSAGE), overcomes this by adjusting energy use in the economic model using information from the energy model. The combined use of these models enables the assessment of fuel-switching and efficiency changes in energy use. Whilst this is a significant improvement to other approaches, the inherent difference in modelling of energy demand makes it difficult to align the two models in terms of energy demand and supply, particularly at the disaggregated household level. Merven et al. (2020) presented an approach to modelling long-term household consumption in the eSAGE model using a Cobb-Douglas functional form, with some advantages compared to the Linear Expenditure System, but the approach is not able to capture technical change that could occur in the private transport sector if EVs were to become cost-competitive. This paper presents a possible approach to passing information about technical change taking place in the private transport sector, as observed in the energy model, to the CGE model in SATIMGE. This approach distinguishes energy demand for private transport from that of other uses in the CGE model such that it better aligns to the TIMES model. This allows for improved analysis of the impacts of changes in transport fuels and fuel volumes on

---

<sup>1</sup> An example of a household end is the use demand for heat. This can be met using different technologies which use different fuels including coal, electricity or natural gas.

the economy. The approach proposed also addresses linkages going from the CGE back to SATIM in terms of the specification of the vehicle-km demand projection (required by SATIM), which takes into account income changes, private transportation costs, budget constraints and other behavioural aspects such as Rebound.

The paper is structured as follows: Section 2 provides a background to private passenger transport in South Africa and the potential shifts that can be expected, based on global trends and changes in technologies. Section 3 reviews previous literature which have taken similar approaches. Section 4 presents the SATIMGE model and outlines the changes made to the TIMES and SAGE models as well as the model links. Section 5 illustrates the impacts of the changes made, and Section 6 concludes with a discussion of further research.

## 2 TRENDS IN PRIVATE TRANSPORT IN SOUTH AFRICA

Private transport accounts for more than a third of total passenger transport in South Africa and comprises two modes, namely motorized and non-motorized. Motorised or car usage accounts for more than half of private transport, with non-motorised options such as walking being concentrated in lower-income groups (StatsSA, 2014; StatsSA, 2019). Despite government efforts to reduce private motorised transport through the introduction of public transport systems such as the Bus Rapid Transit (BRT) systems and the Gautrain rapid rail network, private motorized transport has continued to increase, with its share in private transport increasing from 28.5% in 2003 to 35.9% in 2019 (StatsSA, 2019). The motorization rate of passenger vehicles (per person) in South Africa is estimated to have increased by about 6% per annum between 2013 and 2018.<sup>2</sup>

Private passenger vehicles account for 65% of all vehicles (including the freight fleet) and nearly all of them are powered by ICEs (Deonarain, 2018), with petrol being the primary fuel source and accounting for 86% of fuel demand. Figure 1 presents the passenger vehicle typology by market share and fuel type.

The average passenger vehicle age is reportedly ten years (Lamprecht, 2019), with a fleet CO<sub>2</sub> emissions profile depicted in Figure 2. Vehicle emission legislation currently requires compliance with only Euro-2 emissions standards, well behind Euro-6d emissions for petrol passenger vehicles introduced this year, and more than double the emissions limit. While the Department of Energy (DoE) has targeted the adoption of Euro-5 standards, this has not yet happened. Current fuels in South Africa are also not on-par in terms of the quality required for efficient use (Deonarain, 2018). The Cleans Fuels Phase 2 government programme, which aims to improve domestic fuel production to a minimum standard of Euro-5, has to date not been promulgated, as the investment for the refinery refurbishment remains a subject of negotiation. Private motorized transport accounted for 38% of total transport emissions in 2015.

Globally, policy-based incentives to promote the adoption of zero-emissions vehicles have predominantly centred on global action to reduce GHG emissions and improve local air quality. This has resulted in EVs being the technology of choice by market share. Initial EV adoption has been primarily in the European, North American and Japanese markets. However, EV deployment has recently gained momentum in developing countries such as China, India and some in South America. Locally, it is estimated that approximately 1000 EVs have been sold to date. Although lagging global adoption rates, historical sales suggest a trend of increasing future demand (WattEV2Buy, 2018). Ahjum et al. (2018) suggested that EVs could potentially comprise 80% of new sales of vehicles by 2045, reduce direct emissions from transport by 70%, and halve the energy intensity of private passenger transport.

---

<sup>2</sup> Source: Author's own calculations based on eNatis (2020) and StatsSA (2013; 2018).

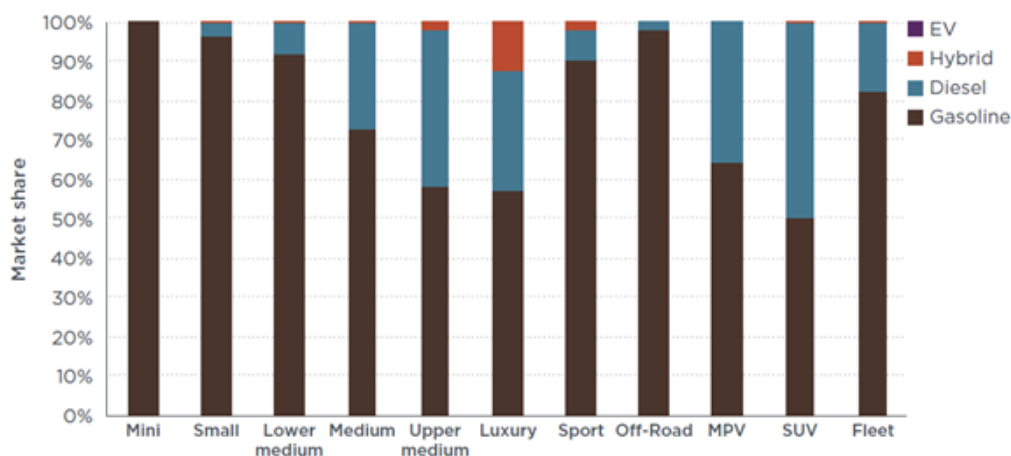

Figure 1: Passenger vehicle typology by market share and fuel type

Source: Posada (2018)

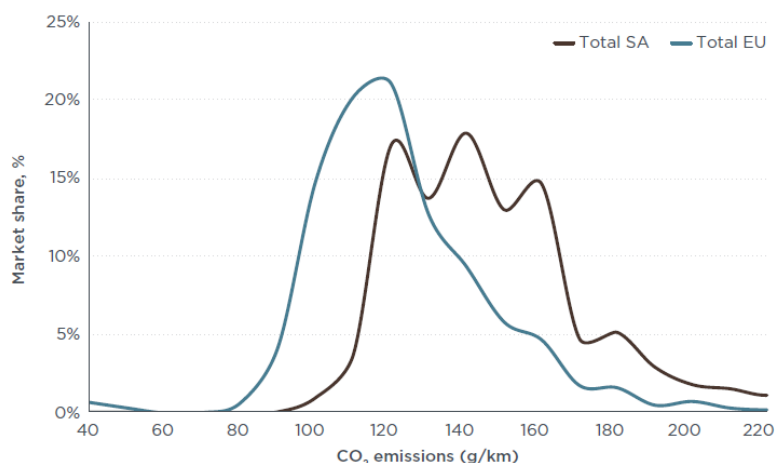

Figure 2: CO<sub>2</sub> emissions distribution for the South African passenger fleet compared to the EU fleet

Source: Posada (2018)

### Hybrid transport modelling in linked energy-economic models

Hybrid bottom-up, top-down (BU-TD) models are needed to robustly assess the long-term changes in transport behaviour over time and hence the implications of this for energy demand and emissions (Creutzig, 2015). Very few linked energy-economic models have taken such an approach; Schäfer (2012) provides a comprehensive assessment of them. This section presents the transport approach taken by some of the models identified by Schafer that are comparable to SATIMGE.

**CIMS:** CIMS combines a technologically detailed bottom-up energy systems simulation model (which includes a high degree of behavioural realism) with a CGE model for Canada. CIMS tracks capital stocks of individual technologies, and for private transport commodities the model distinguishes intercity and intra-urban transport, for personal and high occupancy vehicles as well as transiting, walking and cycling. In determining technology shares, CIMS considers which option is least-cost, using sectoral discount rates, and uses an intangible cost parameter and a market heterogeneity parameter that limits change in market shares compared to previous time periods. All are sector-specific and estimated based on discrete choice surveys for the most important energy-use nodes in the model. Volumes of the aggregate good supplied by different technologies that are consumed in final or intermediate consumption respect macro-economic equilibrium conditions and are determined by price-elastic demand functions (Horne et al., 2005; Bataille et al., 2006 and Jaccard, 2009).

**IMACLIM-R:** The hybrid BU-TD IMACLIM-R *Monde* model considers a mobility service to be one of the products that part of a CES utility function for (aggregate) households in each of the model's 12 world regions. This together with a budget constraint determines the volumes of transport consumed (Crassous et al., 2006; Waisman et al., 2012 and Waisman et al., 2013). Within the mobility service a CES function determines modal shares, dependent on a few modal parameters. The aggregate household's modal choice is also subject to a region-specific constant household time constraint for transport. This time constraint translates into passenger-kms by considering average speeds of the transport mode and is also a function of congestion effects. Finally, vehicle purchases are part of household investment and depends on an income-elastic motorization rate (Waisman et al., 2013). O'Broin and Guivarch (2017) add the estimation of transport infrastructure construction costs to improve the economic evaluation of different scenarios in respect to developments in transport systems.

**ReMIND-G:** ReMIND-G is a hybrid intertemporal optimized model in which a growth model and an energy model are hard-linked. A land use model and a simplified climate model also iterate with the energy model. The use of a growth model implies that there is no product heterogeneity in consumption other than energy consumption, and there is no household disaggregation. Transport is one of the CES inputs into an economy's energy provision (which is part of a CES function with capital and labour), with the demand for different transport modes being modelled as a CES function as well. Technology choice for the different transport modes, like light duty vehicles, is determined by the technologically detailed bottom-up energy system model (Pietzcker et al., 2010 and Luderer, 2015).

**EPPA:** The EPPA model is a CGE model with bottom-up model elements and dynamics (Paltsev et al., 2004; Karplus et al., 2009; Chen et al., 2016). Household budgets for private transport are an elastic part of total household consumption, and the budget constraint is the only constraint on transport use. Within the private transport budget, fuel costs, vehicle (purchase) costs and vehicle operation and maintenance costs are considered.

### 3 METHODOLOGY

SATIMGE is hard-linked energy-economic model for South Africa which combines the South African TIMES (SATIM) model, a full sector energy systems optimization model, with an energy-hybridized recursive dynamic computable general equilibrium (eSAGE) model of the country. The hard-linking of the models combines different aspects of the country, capturing both the technical detail needed for full energy systems modelling and economic detail for assessing the impact of changes in the energy system on various sectors, markets, and agents in the economy, thus addressing the shortcomings of each in energy and climate policy analysis (see Arndt et al., 2016). The two models are run synchronously, passing information in both directions within the annual time step of the CGE model, until convergence on energy demand and supply, and on economic growth is achieved. All these models are well-understood and widely accepted members of a class of simulation model in their respective disciplines. The next sections outline how transport is modelled in the SATIM and eSAGE model and how these interact in the SATIMGE model. This is followed by a description of the changes made to each for this paper.

#### 3.1 Private transport in SATIM

Vehicle-km projections for road vehicles (freight and passenger) are exogenously imposed in SATIM. The least-cost technology and fuel mix, across the full energy supply chain, to meet the projected vehicle-km demands while also meeting other goals such as national emissions constraints, is then found using linear programming optimization techniques. Figure 3 illustrates some of the main components of the supply chain and how it is represented in SATIM.

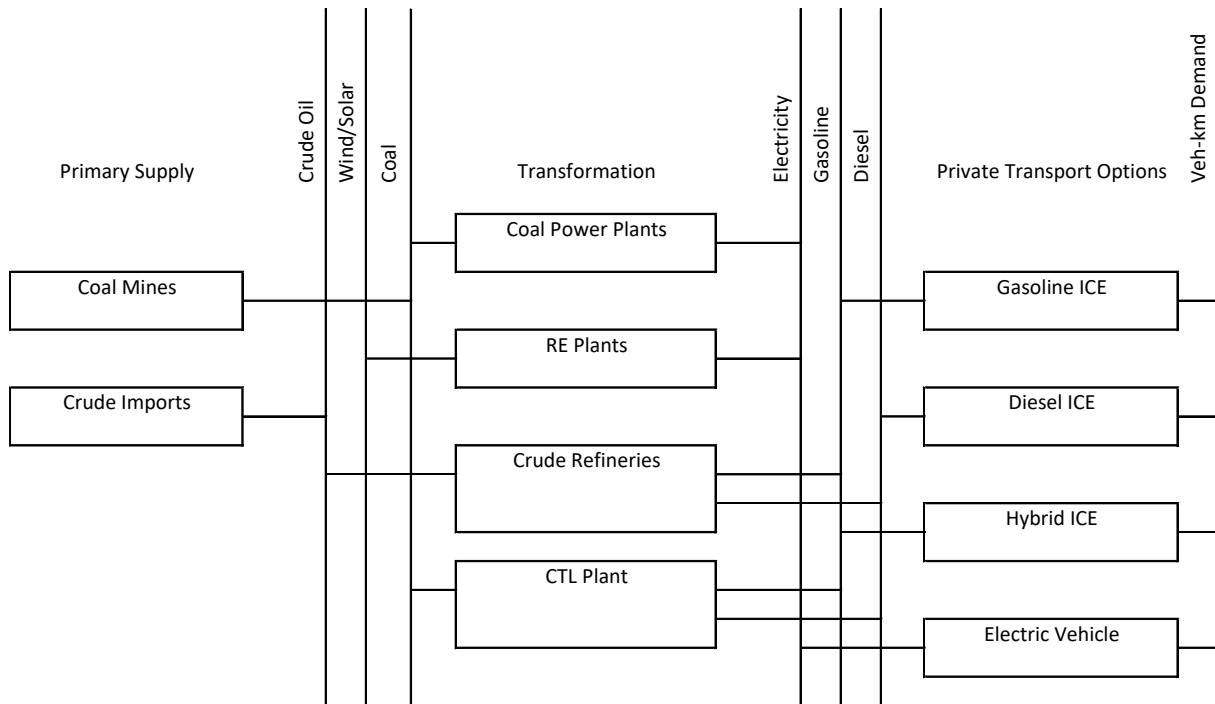

**Figure 3: Illustrative diagram of private transport in SATIM**

Source: Author's illustration

### 3.2 Transport in eSAGE

The eSAGE model uses the 2012 energy-hybridized social accounting matrix (SAM) as the starting point for projections. This hybridized SAM is based on the SAM produced by van Seventer et al. (2016) and the 2012 energy balance.<sup>3</sup> One of the key differences of the energy-hybridized SAM is that it includes three liquid fuel product categories, namely petrol, diesel, and other liquid fuels (primarily paraffin in the case of households). Merven et al. (2019) describes this in further detail.

Private passenger transport in the SAM and eSAGE model is captured by household's expenditure on transport fuels, motor vehicles and vehicle-related expenditures such as the purchase of tyres. Private vehicles in South Africa predominantly use ICE technologies, demanding petrol and diesel inputs. As a result, these fuels comprise a significant share of household budgets, accounting for nearly 5% of total household consumption. Public passenger transport is captured separately through the consumption of passenger transport services.

Household consumption in the CGE model covers all marketed commodities, purchased at market prices that include commodity taxes and transaction costs. Household consumption by income decile is modelled using a Cobb Douglas functional form. Fixed consumption shares in the Cobb Douglas are, however, changed over time to reflect changes in real income and hence associated changes in living standards associated with changes in income. For this see Merven et al., (2020), who show that, under this specification, demand for petrol and diesel increases as household's incomes rise and they demand more private as opposed to public sector transport.

<sup>3</sup> The 2012 energy balance from the Department of Energy (DoE) is used as the starting point for the energy balance used in SATIM and to hybridize the SAM. The DoE energy balance is enhanced with more accurate primary data which is either missing from or miscategorised in the official energy balance.



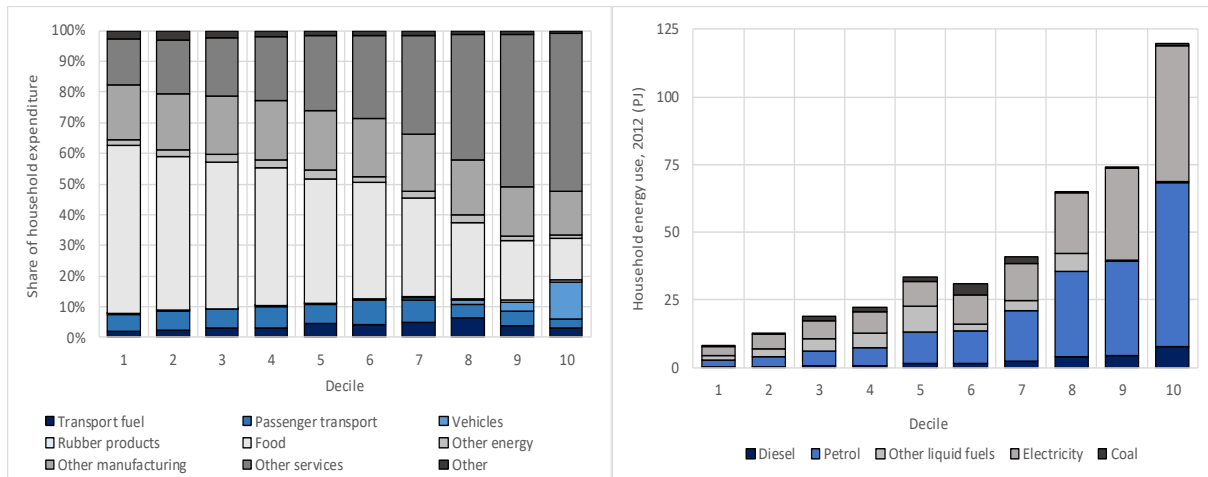
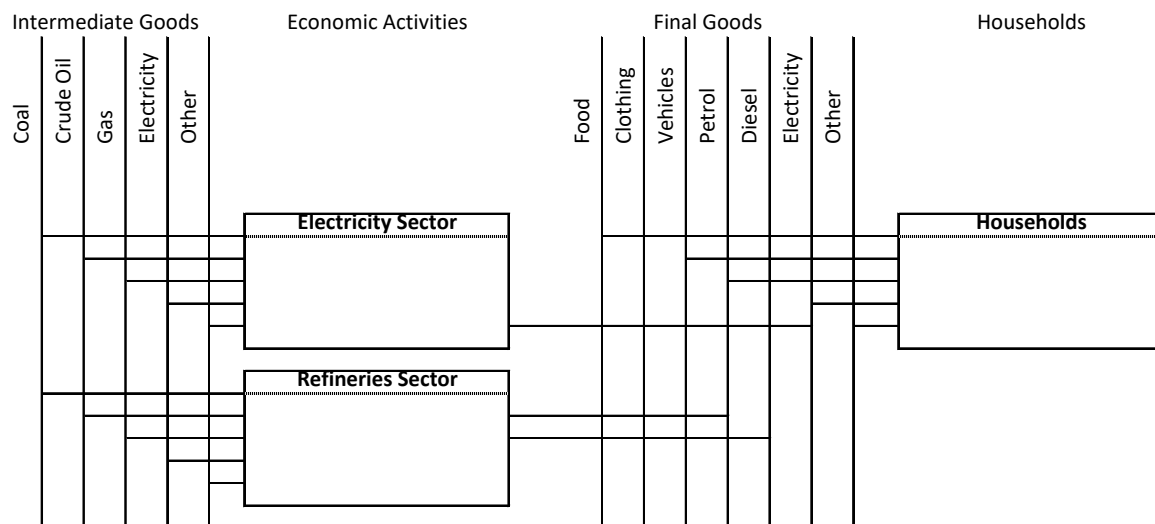

**Figure 4 (a) Household expenditure by commodity; (b) Household energy consumption**  
 Source: 2012 SAM; 2012 Energy Balance

### 3.3 Model changes

#### 3.3.1 SAM and eSAGE model changes

To incorporate an energy end-use demand structure for private transport into the original SAM (partially shown in Figure 5) and eSAGE models, household energy use related to transport is shifted out of the household consumption vector and replaced with a consumption on private transport fuel that is equivalent to the sum of energy use for transport. A new sector is created in the SAM called private transport, as shown in Figure 6. This sector consumes the individual sources of fuels needed for transport and produces the private transport commodity consumed by households. The private transport sector consumes no other goods or services than the fuels available for private transport needs. The sector does also not consume production factors nor does it pay taxes or receive subsidies. Through incorporating the private transport sector and commodity, the private transport end-use is included in the model, and the use of energy for this end-use is separated out.



**Figure 5: Household consumption in original SAM**  
 Source: Author's illustration

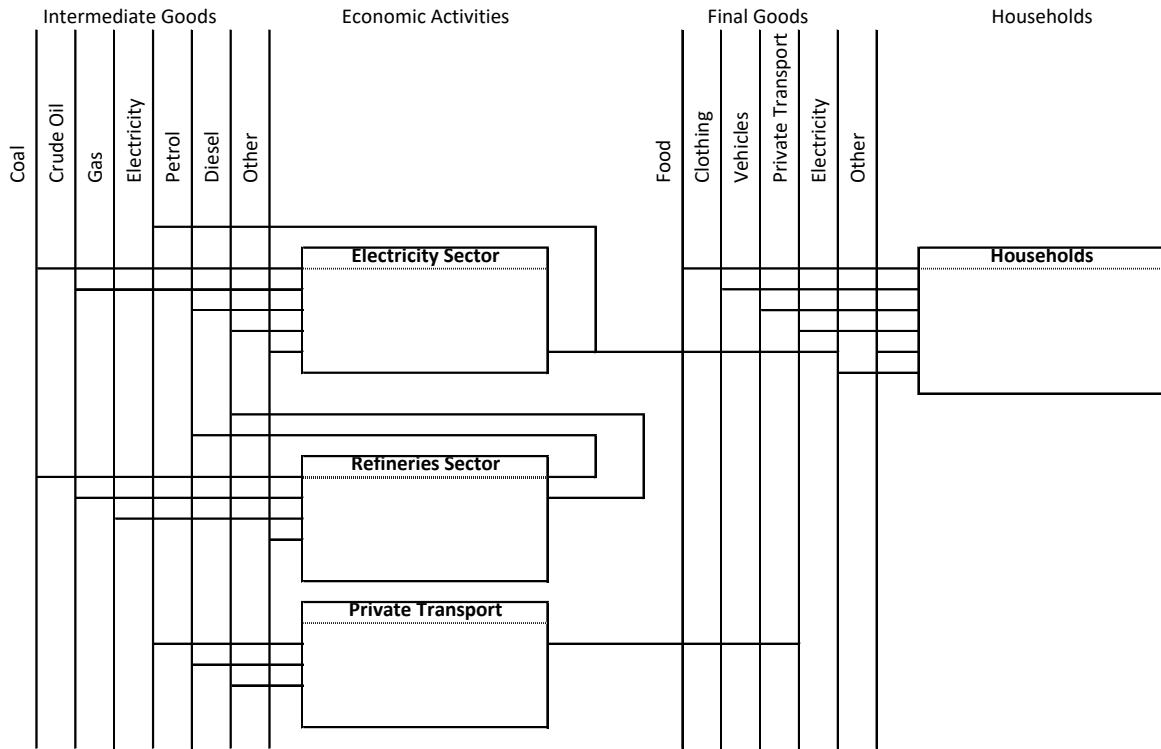

Figure 6: Household consumption with modified SAM

Source: Author's illustration

### 3.3.2 Changes to SATIMGE links

#### Informing technical change in eSAGE from SATIM results

With the new private transport sector activity in place in the SAM, the approach used in Merven et al (2019) can be used to transfer the technical change observed in SATIM across to eSAGE. In eSAGE the composition of intermediate inputs is done using a Leontief representation with the quantity of intermediate input  $c$  required by activity  $a$  in year  $t$ ,  $qint(a, c, t)$ , calculated as Equation 1:

$$qint(a, c, t) = output(a, t) \times ica(a, c, t) \quad [1]$$

where  $ica(a, c, t)$  is a coefficient (which can be time-varying) for each intermediate input commodity,  $c$ . The base year ( $t_0$ )  $ica$  values are derived from the calibrated SAM. The  $ica$  coefficients for each energy intermediate input are calculated from the SATIM results, starting by calculating energy intensity of production in SATIM (Equation 2):

$$Energy\ Intensity(C, t) = \frac{Energy\ Input(C, t)}{Vehicle-km(t)}, \quad [2]$$

where  $Energy\ Input(C, t)$  is the consumption of each commodity  $C$  (gasoline, diesel, electricity) by private sector vehicles as observed in SATIM.

$ica$  for private transport activity,  $ica(PrivTra)$ , is then simply specified to be equal to the energy intensity by fuel observed in SATIM in each time period  $t$ :

$$ica(PrivTra, c, t) = Energy\ Intensity(C, t). \quad [3]$$

#### Driving the Vehicle-km demand in SATIM from eSAGE and the rebound effect

As mentioned above, household consumption by income decile is modelled using a Cobb Douglas functional form. This assumes that a fixed share of the household budget is allocated to each commodity. In the case of a switch to more efficient hybrid vehicles or electric vehicles, lowering the cost of private transportation, this would result in an increase in the consumption of private transportation, the phenomenon described above in

the literature section as *Rebound*. As noted below it is not certain that houses will indeed behave in that way. A new parameter is thus introduced: *Rebound*, set between zero and 1, where a value of 1 would imply a full rebound, with no change in budget share allocations, and a rebound of zero would imply that consumption would stay constant and extra budget made available from the improvement in efficiency would be reallocated to other goods.

In order to calculate the no-rebound budget share, an estimated price change from the technical change that occurs (as observed in SATIM) is first calculated as follows:

$$PQest(PrivTra, t) = \sum_c ica(PrivTra, c, t) \times PQ(c, t - 1), \quad [4]$$

where  $PQ(c, t-1)$  is the observed price for commodity  $c$  in eSAGE in the previous time period.

The budget share with no rebound is then calculated as follows:

$$BudShareNoRebound(PrivTra, t) = \frac{BudShareOriginal(PrivTra, t-1) \times PQest(PrivTra, t)}{PQ(PrivTra, t-1)} \quad [5]$$

The actual budget share allocated to private transport is then calculated as a function of the *Rebound* parameter as follows:

$$BudShareActual(PrivTra, t) = BudShareOriginal(PrivTra, t - 1) \times Rebound(t) + BudShareNoRebound(PrivTra, t) \times (1 - Rebound(t)). \quad [6]$$

The budget share for the other goods are then recalculated as follows:

$$BudShare(Other, t) = \frac{(1 - BudShareActual(PrivTra, t)) \times BudShare(Other, t-1)}{(1 - BudShareActual(PrivTra, t-1))} \quad [7]$$

Having now control over the amount of rebound that is to be modelled in a particular scenario, the demand for Vehicle-km in SATIM can be derived directly from the consumption of the *Private Transport* commodity observed in eSAGE ( $QH(PrivTra)$ ):

$$\Delta Vehicle - km(t) = \Delta QH(PrivTra, t). \quad [8]$$

## 4 COST-COMPETITIVE CLEAN ELECTRICITY AND RESIDENTIAL TRANSPORT

### 4.1 Scenarios and assumptions

Most of the SATIM assumptions are aligned with those of McCall et al. (2019). More specifically relevant to this paper are the following:

- The global discount rate is set to 8.2%.
- Two core scenarios are considered in this paper, EV-IN and EV-OUT, which are primarily distinguished by assumptions about the future cost of vehicle technology (Figure 7). In the EV-IN scenario, electric vehicle technology costs become competitive with internal combustion engines by 2030 as projected by the literature (BNEF, 2019; IEA, 2019). This is the case for both private passenger vehicles and light commercial vehicles (LCVs). The EV-OUT scenario is distinguished by a higher purchase cost of an EV over the period in comparison to ICE or HYBRID-ICE alternatives. A premium of approximately 25% during the period 2030-2050 is applied to an EV in contrast to the present-day total impost of 42% (Kumalo, 2019). In both scenarios, a lower limit on the share of conventional ICE is imposed, one that reduces gradually from current levels (100%) down to around 10% by 2050 (for car and SUV markets).

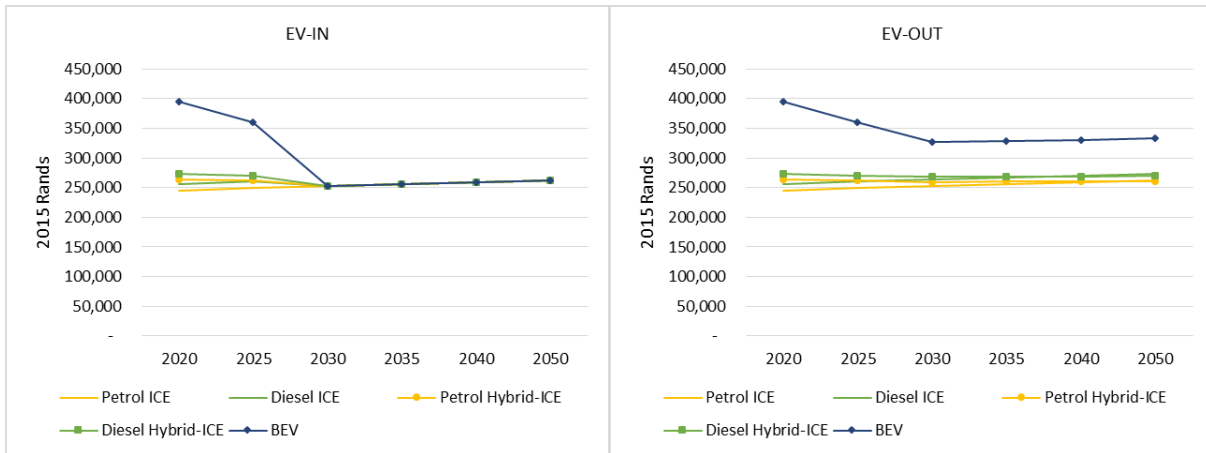
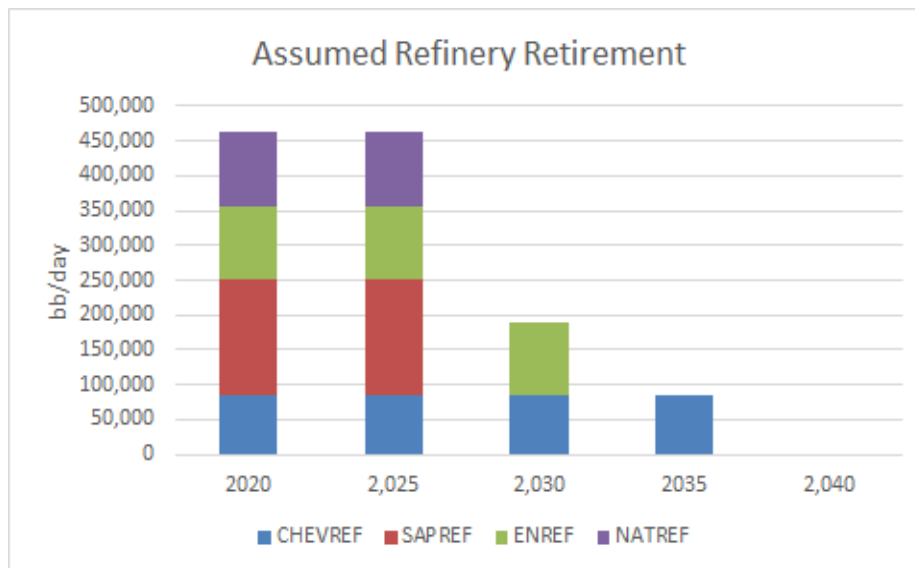

**Figure 7: A comparison of passenger vehicle cost by technology for the scenarios**

Source: EV-IN: adapted from Ricardo-AEA (2012); EV-OUT: SATIM

- The imported crude oil price, which is projected to grow from current levels to USD 80/bbl by 2020 and remain at that level onward.
- The imported LNG price, which is projected to be constant at USD 13/mmbtu.
- It is assumed that no climate change mitigation policy is imposed on the economy.

As per Merven et al (2019), existing refineries can either upgrade to new fuel specifications in 2030 or slowly retire over time. The retirement schedule of the refineries assumed is shown in Figure 8. The order of retirement is arbitrary. A gradual optional retirement is assumed to allow the model to veer away from ICE-based technologies if it is economic to do so. The CTL plant runs to 2040. Hydrogen production is possible either via methane steam reformation (SMR) or water electrolysis. Techno-economic assumptions regarding hydrogen production and distribution follow those in Stone et al (2013).



**Figure 8: Assumed crude refinery retirement profile**

Source: Merven et al, 2019

The model is run from 2012 to 2050 and scenario ‘EV-out’ is treated as the reference case to which results from the ‘EV-in’ scenario are compared. The growth rate in the Reference scenario is targeted to meet actual growth between 2012 and 2017, whilst growth between 2018 and 2050 is based on a combination of projections from the 2018 *Medium-Term Policy Statement* (National Treasury, 2018), October 2018 *World Economic Outlook* (IMF, 2018) and the Department of Energy’s planning average annual growth rate of ~3.0% to 2050.

Exogenous assumptions are the same in all scenarios. The supply of labour is assumed to increase in line with population growth (~0.89%, UNEP 2016), although upward sloping labour supply curves are assumed for all skill categories, given the long-term nature of the analysis, which means that increases in wages resulting from higher labour demand increases the labour force participation rate. Government spending and foreign savings increase by 3% per annum, although the increase in foreign savings decreases over time as debt is repaid. Total factor productivity is adjusted in the Reference scenario to reach the real GDP growth forecasts discussed above.

The macroeconomic closures included are aligned to the stylized facts for South Africa: investment is driven by the total level of savings in the economy, although investment and government expenditure as shares in total absorption are fixed (balanced savings-investment closure); government savings are flexible and no fiscal rule is imposed; the exchange rate is flexible with the level of foreign savings (in foreign currency) rising by an exogenous growth rate which decreases over time as South Africa repays its foreign debt. Existing capital is assumed to be fully employed and activity specific. A least-cost optimal energy pathway from the South African Times model is included. The latter provides information on energy production and investment, and electricity prices.

It is assumed that access to electric vehicles will be the same as ICE and that the domestic and import and export shares of vehicles remain relatively the same as in the base year. Therefore, obstacles in shifting the motor vehicle industry from produce ICE to EVs are not considered, nor is the potential loss in export share from not doing so.

## 4.2 Results

Figure 9 presents the demand for petrol, diesel and electricity from the SATIMGE model under the scenario of EV adoption. The left panel shows the results when the private transport link is not included in the linked model, and the right panel shows the result when it is. As illustrated without the link there is a clear divergence between the models in terms of private transport energy demand, with the CGE model unable to account for the fuel switch taking place in SATIM. The private transport link incorporated into this model ensures that this shift is captured.

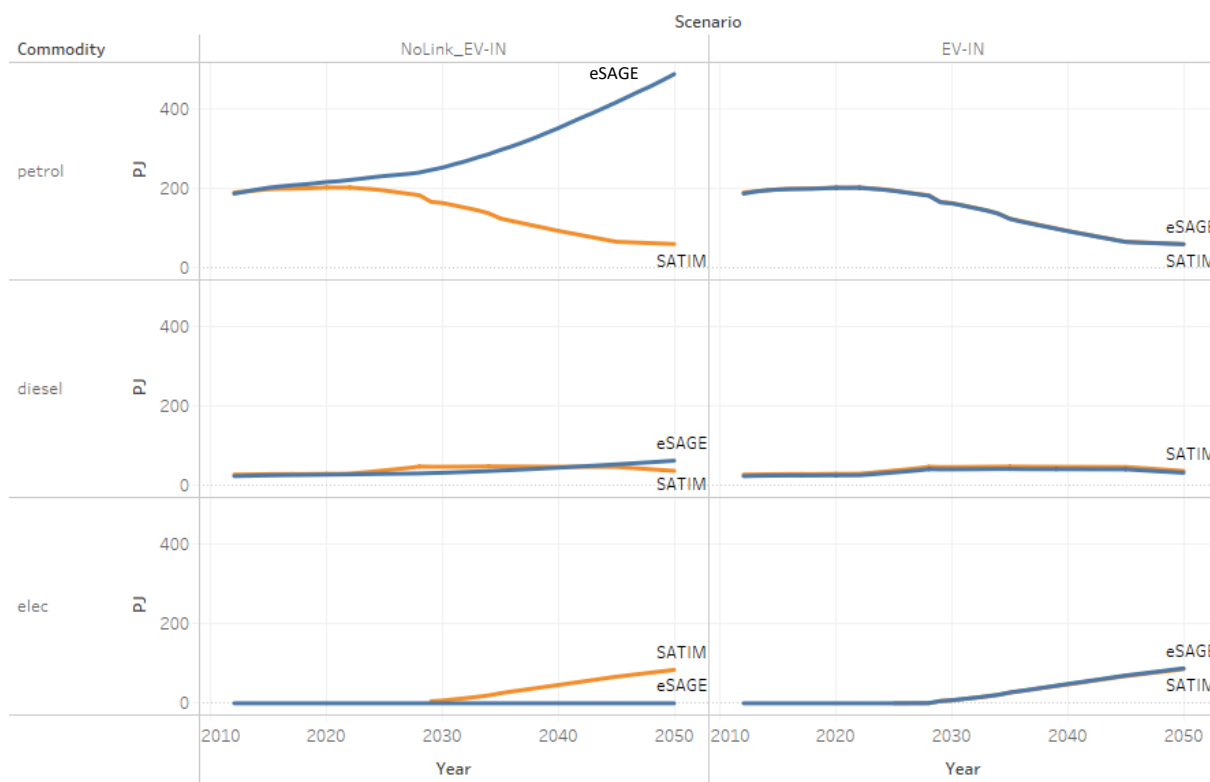
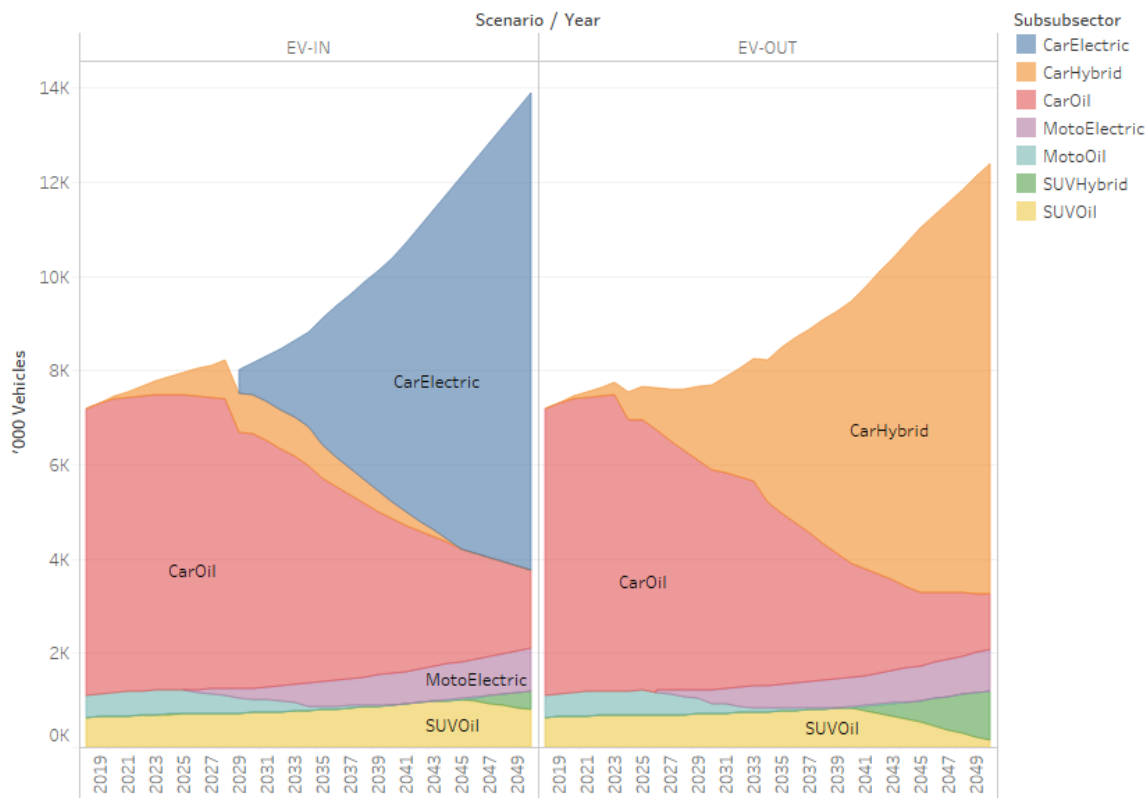

Figure 9: Private transport fuel demand without (NoLink\_EV-IN) and with (EV-IN) link

Source: SATIMGE

### 4.2.1 Evolution of private transport with and without EVs

By 2050, the vehicle parc is dominated by EVs for car and motorcycle markets in the EV-IN scenario, and hybrid vehicles in the EV-OUT scenario, except in the case of the motorcycle fleet (see Figure 10). In the EV-IN scenario, hybrid vehicles play a more transitional role.

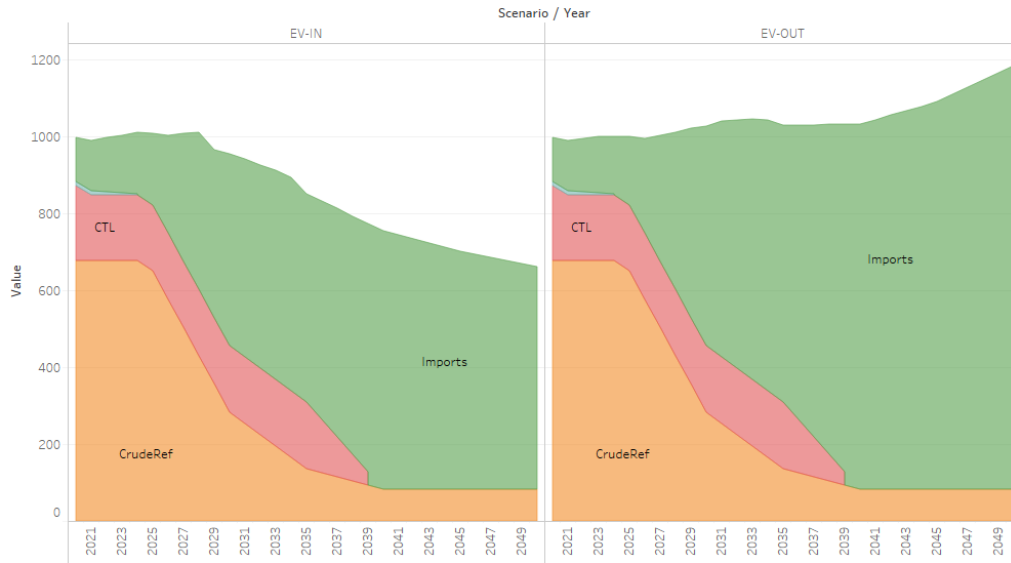

**Figure 10: Private transport vehicle fleet evolution with (EV-IN) and without (EV-OUT) EV adoption**  
Source: SATIMGE

### 4.2.2 Impact on liquid fuel supply and demand

In the EV-OUT scenario, liquid fuel demand and supply is expected to rise to 2050 as fossil-based vehicles remain a key source of mobility in the country. Between 2018 and 2050, the demand for liquid fuels increases, at first more slowly before accelerating in the later years, mainly driven by increasing household income. In the short-to-medium term, this demand is met primarily by domestic production, using crude oil refineries. Over the longer term, however, domestic supply is replaced with imported products, which is more cost-competitive<sup>4</sup> (see Figure 11). The adoption of electric vehicles has an impact on the volume of liquid fuels required. Liquid fuels requirements decline from around 1000 PJ per year to around 660 PJ by 2050.

<sup>4</sup> Note that the import vs domestic refining result is sensitive to a wide range of other assumptions, which are not the focus of this current paper. These include assumed cost for the Euro-5 upgrade, the global refinery margins, etc. However, if products were not imported, crude oil would have to be imported instead, as South Africa currently does not have known sizeable economically accessible crude reserves.



**Figure 11: Fuel supply with (EV-in) and without (EV-out) EV adoption**  
Source: SATIMGE

The decline in total fuel demand stems from the decline in demand from private passenger transport, and LCVs in the freight sector from the switch to EVs (see Figure 12).

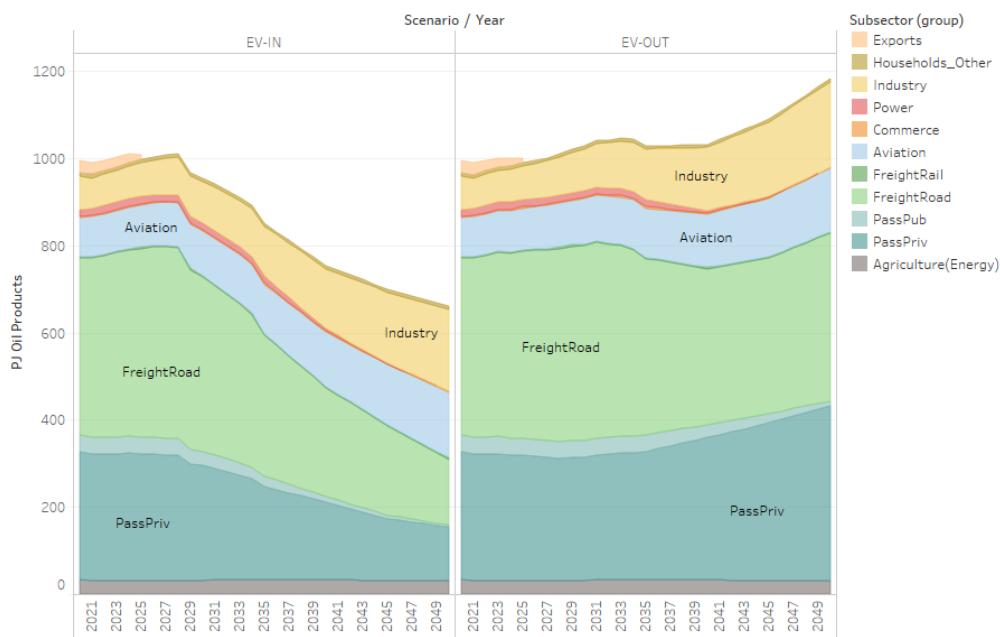

**Figure 12: Liquid fuel demand by sector with (EV-IN) and without (EV-OUT) EV adoption**  
Source: SATIMGE

The replacement of liquid fuels with electricity in the EV-in scenario leads to a rise in demand for electricity over the modelled period (see Figure 13). This is exacerbated by EVs penetrating the LCV market (not shown here).

In the EV-IN scenario, EVs for private transport, and EVs in the LCV market each add around 30 TWh. This combines to around 11% of the total electricity demand in 2050. The additional supply is met by increase solar PV and wind generation, which produce more than 70% of electricity in South Africa under least-cost conditions.

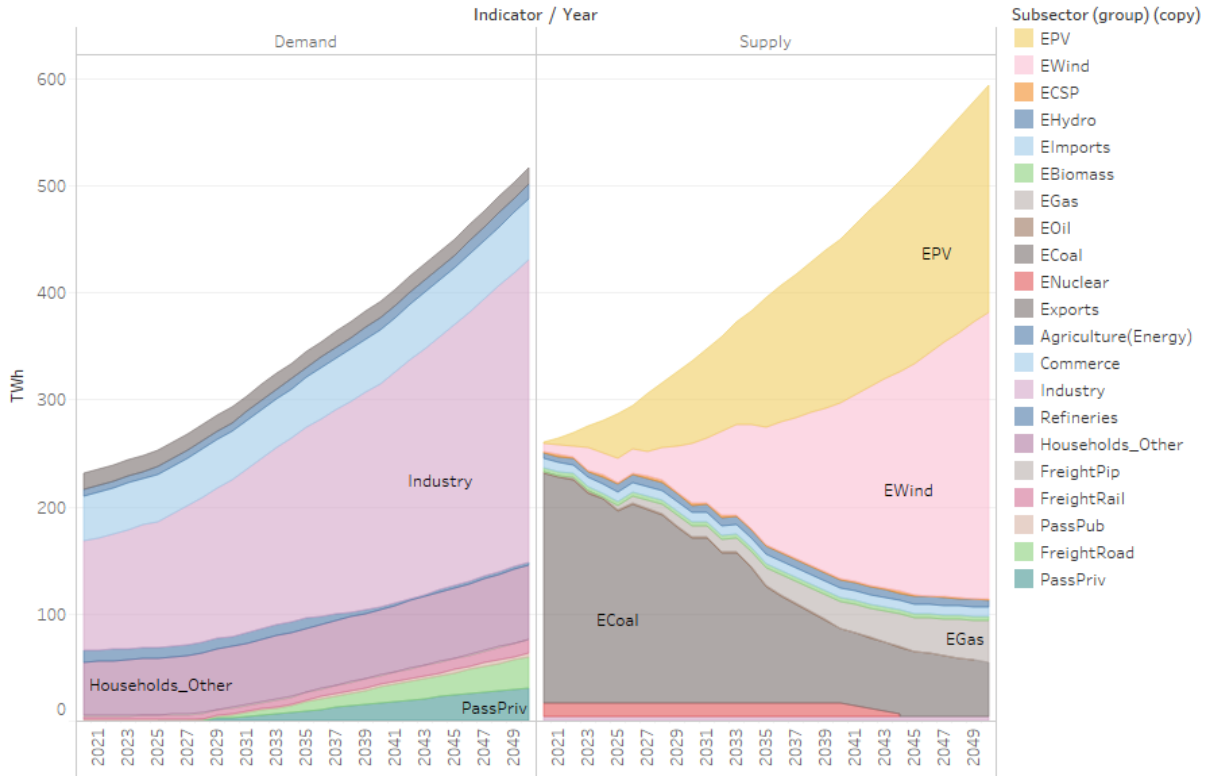

**Figure 13: Electricity demand and supply by technology in EV-IN scenario**  
Source: SATIMGE

### 4.2.3 Transport sector emissions

Figure 14 presents total annual CO<sub>2</sub>-eq energy-related emissions by sector for the two scenarios. The transport sector emissions are 47% lower in the EV-IN scenario relative to the EV-OUT scenario. With the assumption of the retirement of Secunda in both scenarios, refinery sector emissions are not very different. The power sector emissions in the EV-IN scenario are 2% higher. Overall, emissions are 12% lower in the EV-IN scenario.

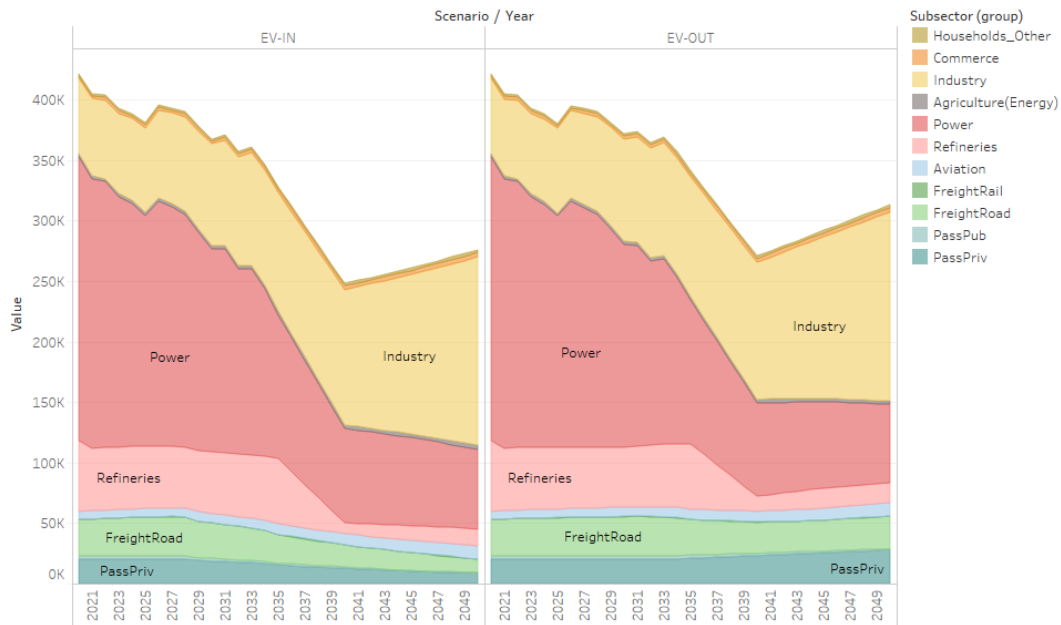

**Figure 14: Energy-related emissions by sector with (EV-IN) and without (EV-OUT) EV adoption**  
Source: SATIMGE



#### 4.2.4 Economic impact

Table 1 presents the economic impact of EV adoption by 2030 and 2050. The results show that, in the medium term, the switch from ICE to EVs has a small negative impact on GDP and employment. The level of real GDP by 2030 is 0.09% lower, whilst 21 000 fewer people are employed. The short-term negative impact is driven by a crowding-out of investment by the electricity sector explaining the decline in GVA across all sectors. EV adoption increases the demand for electricity resulting in increased capacity to support supply. Electricity investment increases by 7.0% per annum between 2018 and 2030 in the EV-in scenario, compared to 6.9% in the EV-out scenario. Cumulative investment is R20.6 billion higher in the EV-in scenario by 2030.

Over the longer term, however, the adoption of EVs leads to higher real GDP (~0.4%), with 410 000 additional jobs being created relative to a scenario of no EV adoption. The decline in demand for petrol results in a decrease in imports relative to the EV-out scenario. This results in a stronger exchange rate, which negatively affects tradeable sectors, as can be seen by the GVA decline in mining, chemicals and other manufacturing. The switch to EVs reduces household expenditure on fuel (see Figure 15).<sup>5</sup> The decline in fuel consumption, with no rebound, enables increased consumption of other goods and services. Sectors providing these goods and services, and those closely related to them, experience an increase in GVA.

While not presented here, government indirect revenues increase in the EV-in scenario relative to the EV-out scenario despite lower fuel sales. The rise in revenues is the result of increased household spending which increases revenues from sales taxes such as VAT.



**Figure 15: Household private transport fuel use with (EV-in) and without (EV-out) EV adoption**  
Source: SATIMGE

<sup>5</sup> Note that the consumption of liquid fuels by households in Figure 15 is lower than that is shown in figure 12. This is because, in Figure 12, Passpriv also includes fuel purchases for use in cars by other agents than domestic households (e.g. companies, foreign tourists, and government.) The share of consumption of fuels by households is estimated to be around 80% of consumption for cars, based on the energy-calibrated SAM.

**Table 1: GDP and employment impact – EV-in relative to EV-out**

	Change in			
	GDP level (%)		Employment	
	2030	2050	2030	2050
GDP	-0.09	0.37	-20 761	410 210
Agriculture	-0.45	-0.06	-5 876	11 729
Mining	-0.47	-4.62	-3 736	-35 345
Manufacturing	-0.17	-1.06	-9 447	-23 023
Food and beverages	-0.42	0.14	-2 310	5 966
Textiles	-0.46	0.15	-1 853	1 828
Wood and paper	-0.36	-0.04	-1 082	3 254
Petroleum	0.00	0.00	0	0
Chemicals	1.53	-2.25	2 773	-8 825
Non-metals	-0.30	0.25	-386	2 249
Metals	-0.85	-4.14	-3 863	-24 262
Machinery	-0.49	-0.72	-1 182	-2 678
Vehicles	-0.19	0.68	-76	2 414
Other manufacturing	-0.77	-2.47	-1 467	-2 970
Other industry	0.70	3.90	1 351	48 343
Electricity, gas and water	1.57	8.06	1 432	13 914
Construction	-0.15	0.48	-81	34 429
Services	-0.10	0.85	-3 053	408 506
Trade	-0.17	0.56	-9 080	90 021
Finance and business	-0.18	0.74	421	98 476
Transport and communication	0.22	1.54	6 581	30 968
Government	-0.09	0.75	-874	23 420
Other	-0.16	0.83	1 220	168 751

Source: SATIMGE

#### 4.2.5 Sensitivity to rebound level

The above discussion of the results has focused on a rebound level of zero, meaning that the full effects of switching to more efficient energy sources in transport are captured. There is, however, an ongoing debate as to whether people will be travelling more (or longer) when facing lower costs per km, and, if so, how much more. Estimates of the rebound effect have ranged from zero to 0.3 (see Seebauer, 2018; Gillingham et al., 2013). Gillingham et al. (2013), however, argue that the km impact is likely closer to lower estimates, between 0.05 and 0.1, as household behavioural responses are more strongly linked to price changes than efficiency changes. For the case of South Africa, no estimates of a potential range of rebound impacts for the country could be found in the literature. For this reason, estimates of the long-term price elasticity of petrol are used here as an indicator of the impact of improved fuel economy on transport demand, even though the degree of rebound effects accounts for more than just the change in fuel costs. Two additional scenarios based on petrol price elasticities from Boshoff (2012) are considered.

Figure 16 presents the change in household transport fuel demand for two additional scenarios, under which the rebound level is set to 0.25 (EV-IN\_RB-0-25) and 0.5 (EV-IN\_RB-0-5). Household transport fuel demand is 42% higher in EV-IN\_RB-0-25 and double EV-IN in EV-IN\_RB-0-5 by 2050. The demand for electricity rises from 23 TWh in the EV-in scenario in 2050 to 33.4 and 47.8 TWh in the EV-IN\_RB-0-25 and EV-IN\_RB-0-5 scenarios respectively. The higher demand for electricity requires additional new capacity. As a result, cumulative electricity investment is 5.4% and 2.2% higher in the EV-IN\_RB-0-25 and EV-IN\_RB-0-5 scenarios than in the EV-in scenario. Emissions are 1.7% and 4.1% higher than the zero rebound case, but, relative to the EV-OUT cases, savings are similar.

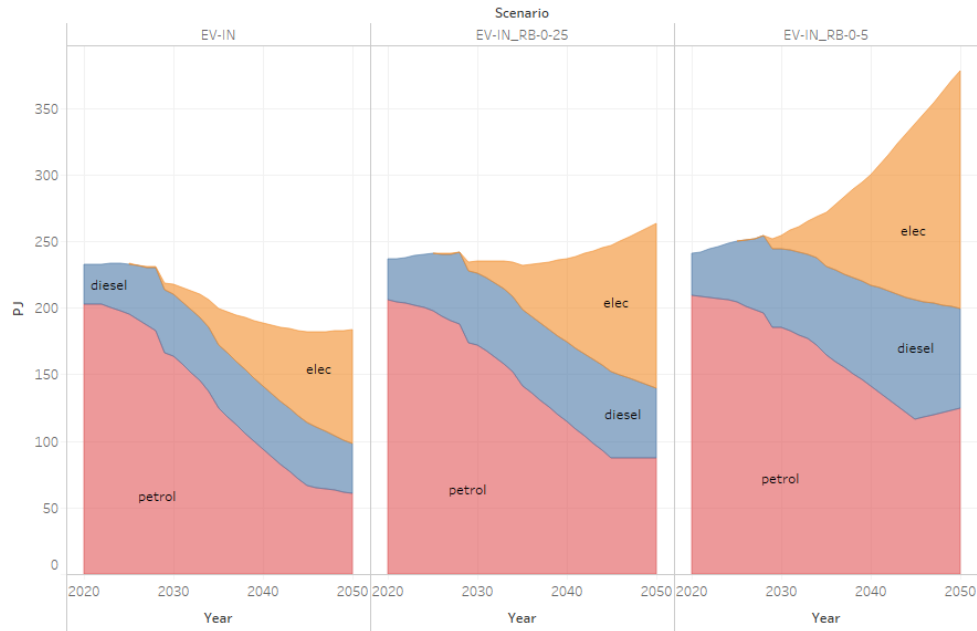

**Figure 16: Impact of rebound assumption on household private transport fuel demand**  
 Source: SATIMGE

Table 2 presents the impacts of EV adoption on GDP and employment for each rebound condition. The results show that an increase in the rebound decreases the positive impact on GDP and employment, as less of the efficiency saving in private transport fuel consumption is filtered to the rest of the economy and more investment in the electricity sector is required, crowding out capital growth in other sectors of the economy.

**Table 2: Impact of rebound assumption on GDP and employment impacts**

	Change by 2050 in					
	GDP level (%)			Employment		
Rebound	0	0.25	0.5	0	0.25	0.5
GDP	0.37	0.30	0.19	410 210	369 266	303 172
Agriculture	-0.06	-0.23	-0.51	11 729	9 353	5 571
Mining	-4.62	-4.79	-4.90	-35 345	-37 098	-38 175
Manufacturing	-1.06	-1.21	-1.44	-23 023	-30 221	-40 286
Food and beverages	0.14	-0.03	-0.33	5 966	4 670	2 486
Textiles	0.15	-0.01	-0.27	1 828	743	-1 057
Wood and paper	-0.04	-0.17	-0.38	3 254	2 492	1 264
Petroleum	0.00	0.00	0.00	0	0	0
Chemicals	-2.25	-2.40	-2.61	-8 825	-9 752	-11 051
Non-metals	0.25	0.14	-0.04	2 249	1 955	1 499
Metals	-4.14	-4.33	-4.49	-24 262	-25 905	-27 450
Machinery	-0.72	-0.82	-0.94	-2 678	-3 082	-3 536
Vehicles	0.68	0.55	0.34	2 414	2 110	1 610
Other manufacturing	-2.47	-2.69	-2.95	-2 970	-3 452	-4 051
Other industry	3.90	4.61	5.62	48 343	48 824	48 904
Electricity, gas and water	8.06	9.72	12.12	13 914	16 437	20 115
Construction	0.48	0.40	0.26	34 429	32 387	28 788
Services	0.85	0.74	0.55	408 506	378 407	327 159
Trade	0.56	0.48	0.31	90 021	83 333	70 498
Finance and business	0.74	0.61	0.37	98 476	92 615	82 394
Transport and communication	1.54	1.40	1.21	30 968	28 818	26 529
Government	0.75	0.70	0.62	23 420	22 196	20 510
Other	0.83	0.69	0.44	168 751	154 993	131 226

Source: SATIMGE

## 5 DISCUSSION AND FURTHER WORK

Merven et al. (2020) presented an approach to modelling long term household consumption in the eSAGE model using a Coub-Douglas functional form, with some advantages compared to the linear expenditure system, but the approach is not able to capture technical change that could occur in the private transport sector if EVs were to become cost competitive. This paper presented a possible approach to passing information about technical change taking place in the private transport sector, as observed in the energy model, to the CGE model in SATIMGE. The approach proposed also addresses linkages going from the CGE back to SATIM in terms of the specification of the vehicle-km demand projection (required by SATIM), which takes into account household income changes, private transportation prices, budget constraints and other behavioural aspects such as rebound. The finding from this model development is that it improves the comparability between the eSAGE and SATIM in terms of how energy demand evolves over time. The change in methodology suggests that, particularly with regard to households, shifting towards an end-use approach for energy commodities might be useful and could be applied to other end-uses where energy efficiency and fuel switching would occur, such as water- and space-heating.

A shortcoming of the private transport commodity included in the eSAGE model is that it accounts only for fuel use associated with private transport. Private transport, however, also includes costs associated with the maintenance and purchasing of vehicles. This is not included in the new activity and commodity and is still modelled as before, as constant shares of household expenditure. Future work would be to a) add the full private transport vector; b) create nested functions such that transport demand is a single commodity consumed by households but that can be provided by the private or public sector.

The paper also considered the impact of EV adoption in South Africa. The results show that shifting from vehicles using fossil fuel technologies to EVs would be beneficial for emissions reductions without being harmful to economic growth over the long-term. The impact on the economy is, however, dependent on the behavioural response to fuel economy improvements. Further research is required to better understand this in the case of South Africa.

## REFERENCES

- Ahjum F., Merven B., Stone A. and Caetano T. 2018. Road transport vehicles in South Africa towards 2050: Factors influencing technology choice and implications for fuel supply. *Journal of Energy in Southern Africa* 29(3): 33-50. <https://doi.org/10.17159/2413-3051/2018/v29i3a5596>.
- Ahjum F., Hartley F. and Merven B. 2019. An assessment of the GHG mitigation potential of land transport pathways presented in the Green Transport Strategy for South Africa and their economy-wide impact. University of Cape Town, Cape Town, South Africa.
- Arndt, C., Davies, R., Gabriel, S., Makrelov, K., Merven, B., Hartley, F. and Thurlow, J. 2016. A sequential approach to integrated energy modelling in South Africa. *Applied Energy* 161: 591-599.
- Bataille, C., Jaccard, M., Nyboer, J., Rivers, N. 2006. Towards general equilibrium in a technology-rich model with empirically estimated behavioral parameters. *The Energy Journal* 27: *Special Issue: Hybrid modeling of energy-environment policies: Reconciling bottom-up and top-down*: 93-112.
- BNEF [Bloomberg NEF]. 2019. Electric vehicle outlook 2019. Online: <https://about.bnef.com/electric-vehicle-outlook/> Accessed [30/03/2020].
- Boshoff, W. H. 2012. Gasoline, diesel fuel and jet fuel demand in South Africa. *Studies in Economics and Econometrics* 36(1): 43 – 78.
- Chen Y.-H., Paltsev, S., Reilly, J.M., Morris, J.F., Babiker, M.H. 2016. Long-term economic modeling for climate change assessment. *Economic Modelling*, 52(Part B): 867–883. <http://dx.doi.org/10.1016/j.econmod.2015.10.023>
- Crassous, R., Hourcade, J. C., and Sassi, O. 2006. Endogenous structural change and climate targets modeling experiments with Imaclim-R. *The Energy Journal: Endogenous technological change. Special issue* 1:259-276.
- Creutzig, F. 2015. Evolving Narratives of Low-Carbon Futures in Transportation. *Transport Reviews* 36(3): 341-360. <http://dx.doi.org/10.1080/01441647.2015.1079277>.
- Deonarain, B. 2018. Improving vehicle technologies for sustainable development in South Africa. *Tips Policy Brief*: 3/2018.
- eNatis [electronic National Administration Traffic Information System]. 2020. Vehicle population statistics. Online: <http://www.enatis.com/index.php/statistics/13-live-vehicle-population> Accessed [30/03/2020]
- Gillingham, K., Kotchen, M., Rapson, D. et al. 2013. The rebound effect is overplayed. *Nature* 493: 475–476. <https://doi.org/10.1038/493475a>.
- Horne M., Jaccard M. and Tiedemann K., 2005. Improving behavioral realism in hybrid energy-economy models using discrete choice studies of personal transportation decisions. *Energy Economics* 27:59-77.
- IEA [International Energy Agency]. 2019. Global EV outlook. Technology report, May 2019. Available <https://www.iea.org/reports/global-ev-outlook-2019> [Accessed: 26/03/2020].
- IMF [International Monetary Fund]. 2018. *World economic outlook. Challenges to steady growth*. October 2018.

- Jaccard, M. 2009. Combining top down and bottom up in energy economy models. In: Evans, J, and Hunt, L.C. (eds) *International handbook on the economics of energy*: Ch. 13. Edward Elgar, Cheltenham/Northampton.
- Karplus, V.J., Paltsev, S., Reilly, J.M. 2009. Prospects for Plug-in Hybrid Electric Vehicles in the United States and Japan: A General Equilibrium Analysis. Report no. 172, MIT Joint Program on the Science and Policy of Global Change, Cambridge (MA)
- Kumalo K. 2019. Electric vehicles: Market intelligence report 2019. GreenCape. South Africa. Online: <https://www.greencape.co.za/assets/Uploads/ELECTRIC-VEHICLES-MARKET-INTELLIGENCE-REPORT-WEB4.pdf>.
- Lamprecht N. 2019. Automotive Export Manual - 2019 - South Africa. Automotive Industry Export Council. South Africa. Online: <http://www.aiec.co.za/Reports/AutomotiveExportManual.pdf> [Accessed: 26/03/2020]
- Luderer, G., Leimbach, M., Bauer, N., Kriegler, E., Baumstark, L., Bertram, C., Giannousakis, A., Hilaire, J., Klein, D., Levesque, A., Mouratiadou, I., Pehl, M., Pietzcker, R., Piontek, F., Roming, N., Schultes, V., Schwanz, J., Strefler, J. 2015. Description of the REMIND model (Version 1.6). PIK, Potsdam, Available at: [https://papers.ssrn.com/sol3/papers.cfm?abstract\\_id=2697070](https://papers.ssrn.com/sol3/papers.cfm?abstract_id=2697070) (accessed 25 March 2020)
- McCall, B., Burton, J., Marquard, A., Hartley, F., Ahjum, F., Ireland, G. and Merven, B. 2019. Least cost integrated resource planning and cost-optimal climate change mitigation policy — Alternatives for the South African electricity system. SA-TIED working paper 29.
- Merven, B., Hartley, F. and Ahjum, F. 2019. Road freight and energy in South Africa. SA-TIED working paper 60.
- Merven, B., Hartley, F., McCall, B., Burton, B., and Schers, J. 2019. Improved representation of coal supply for the power sector for South Africa. SA-TIED working paper 84.
- Merven, B., Hartley, F. and Schers, J. 2020. Long term modelling of household demand and its implications for energy planning. SA-TIED working paper 99.
- National Treasury. 2018. *Medium term budget policy statement*. Republic of South Africa.
- Ó Broin, E. and Guivarch, C. 2017. Transport infrastructure costs in low-carbon pathways. *Transportation Research Part D: Transport and Environment* (55):389-403.
- Posada F. 2018. South Africa's new passenger vehicle CO<sub>2</sub> emission standards: Baseline determination and benefits assessment. International Council on Clean Transportation (ICCT). USA. Online: [https://www.theicct.org/sites/default/files/publications/South-Africa-PV-emission-stds\\_ICCT-White-Paper\\_17012018\\_vF.pdf](https://www.theicct.org/sites/default/files/publications/South-Africa-PV-emission-stds_ICCT-White-Paper_17012018_vF.pdf).
- Pietzcker, R., Moll, R., Bauer, N, Luderer, G., 2010. Vehicle technologies and shifts in modal split as mitigation options towards a 2°C climate target. Contribution to the 2010 ISEE conference: Advancing Sustainability in a Time of Crisis, Bremen/Oldenburg
- Paltsev, S., Reilly, J.M., Jacoby, H.D., Eckaus, R.S., McFarland, J., Sarofim, M., Asadoorian, M., and Babiker, M. 2005. The MIT Emissions Prediction and Policy Analysis. (EPPA) Model: Version 4. Report no. 125, MIT Joint Program on the Science and Policy of Global Change, Cambridge (MA)
- Ricardo-AEA. 2012. Road vehicle cost and efficiency calculation framework 2010-2050. Report#ED57444. United Kingdom
- Schäfer, A. 2012. Introducing behavioural change in transportation into energy/economy/environment models. Policy Research Working Paper 6234, World Bank, Washington DC.
- Seebauer, S. 2018. The psychology of rebound effects: Explaining energy efficiency rebound behaviours with electric vehicles and building insulation in Austria. *Energy Research & Social Science* 46:311-320.
- StatsSA [Statistics South Africa]. 2013. *Mid-year population estimates 2013*. South Africa. Online: <https://www.statssa.gov.za/publications/P0302/P03022013.pdf>
- StatsSA [Statistics South Africa]. 2014. *National household travel survey*. South Africa. Online: <http://www.statssa.gov.za/publications/P0320/P03202013.pdf>

- StatsSA [Statistics South Africa]. 2018. *Mid-year population estimates 2018*. South Africa. Online: <http://www.statssa.gov.za/?p=11341>
- StatsSA [Statistics South Africa]. 2019. *General household survey, 2018*. South Africa. Online: <http://www.statssa.gov.za/publications/P0318/P03182018.pdf>
- Stone, A., Merven, B. And Senatla, 2013, M., Exploring pathways to a hydrogen fuel cell transition in the South African road transport sector: A pre-study. In: *South Africa and the global hydrogen economy: The strategic role of platinum group metals*: Ch. 5. Mapungubwe Institute for Strategic Reflection, Johannesburg.
- UNEP [United Nations Environmental Programme]. 2016. Obtaining long-term forecasts of the key drivers of greenhouse gas emissions in South Africa. UNEP-DTU Partnership/ERC/FIRM. Copenhagen: United Nations Environment Programme.
- Van Seventer, D., Hartley, F., Gabriel, S. & Davies, R. 2016. A 2012 social accounting matrix (SAM) for South Africa. WIDER Working Paper 2016/26. Helsinki: UNU-WIDER.
- Waisman, H., Guivarch, C., Grazi, F. and Hourcade, JC. 2012. The IMACLIM-R model: Infrastructures, technical inertia and the costs of low carbon futures under imperfect foresight. *Climatic Change* 114: 101–120. DOI 10.1007/s10584-011-0387-z.
- Waisman H-D, Guivarch, C., Lecocq, F. 2013. The transportation sector and low-carbon growth pathways: modelling urban, infrastructure, and spatial determinants of mobility, *Climate Policy* 13:sup01: 106-129. DOI: 10.1080/14693062.2012.735916.



## About the authors

---

Bruno Merven leads the Energy Systems Research Group at the University of Cape Town. Faaiga Hartley and Fadiel Ahjum are researchers within the group and Jules Schers is a visiting researcher from Expertise France. All are involved in the development and maintenance of the Group's energy, economic and linked energy-economic model.

**INTERNATIONAL FOOD POLICY RESEARCH INSTITUTE**  
A world free of hunger and malnutrition  
1201 Eye Street, NW | Washington, DC 20005-3915 USA  
T: +1.202.862.5600 | F: +1.202.862.5606  
Email: [ifpri@cgiar.org](mailto:ifpri@cgiar.org) | [www.ifpri.org](http://www.ifpri.org)

This paper was prepared as an output for the Towards Inclusive Economic Development in Southern Africa (SA-TIED) project and has not been peer reviewed. Any opinions stated herein are those of the authors and not necessarily representative of or endorsed by IFPRI. The boundaries, names, and designations used in this publication do not imply official endorsement or acceptance by the authors, the International Food Policy Research Institute (IFPRI), or its partners and donors.